

Foam dosing Products

Made in Germany

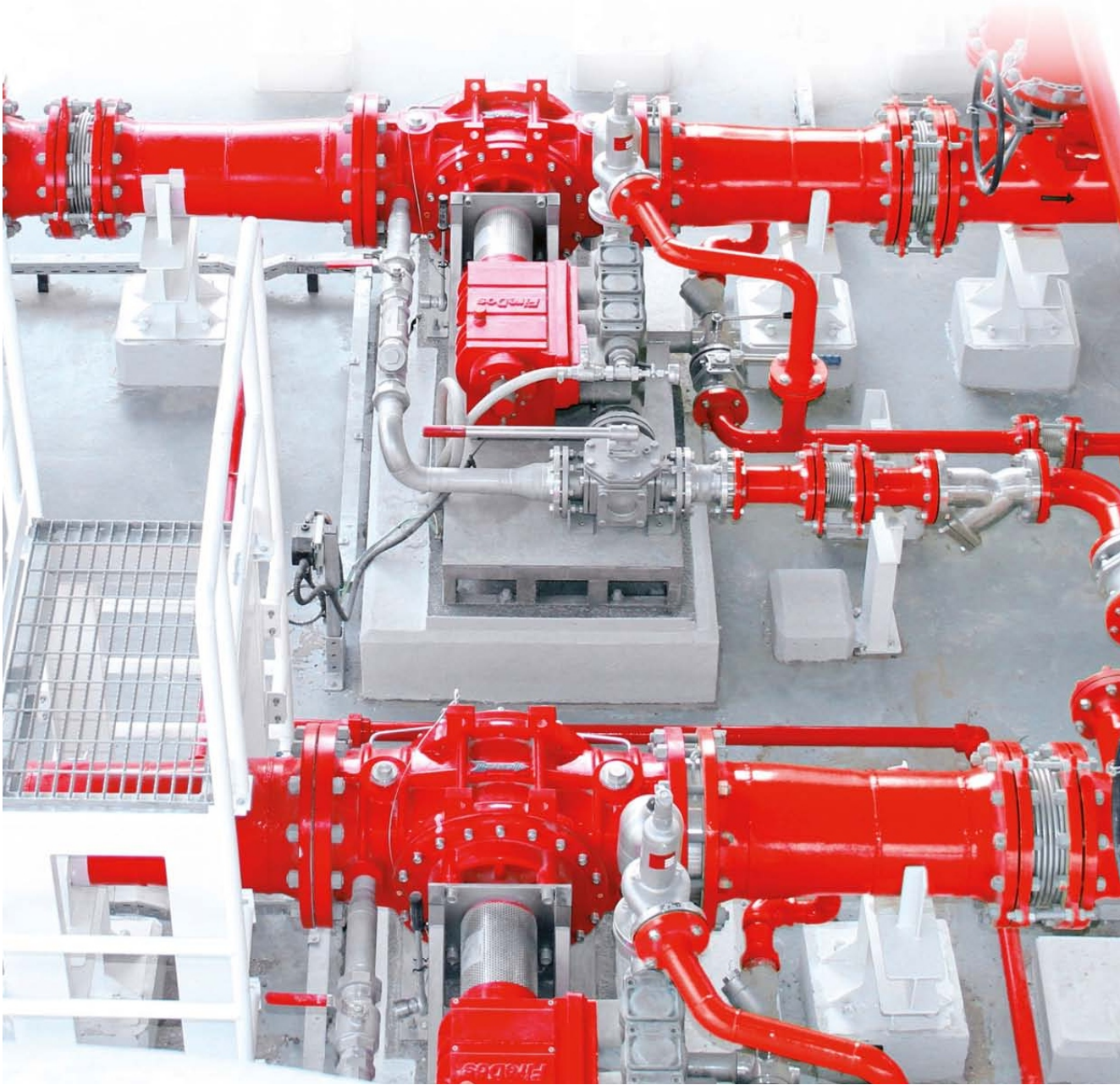

FOR STATIONARY EXTINGUISHING SYSTEMS.

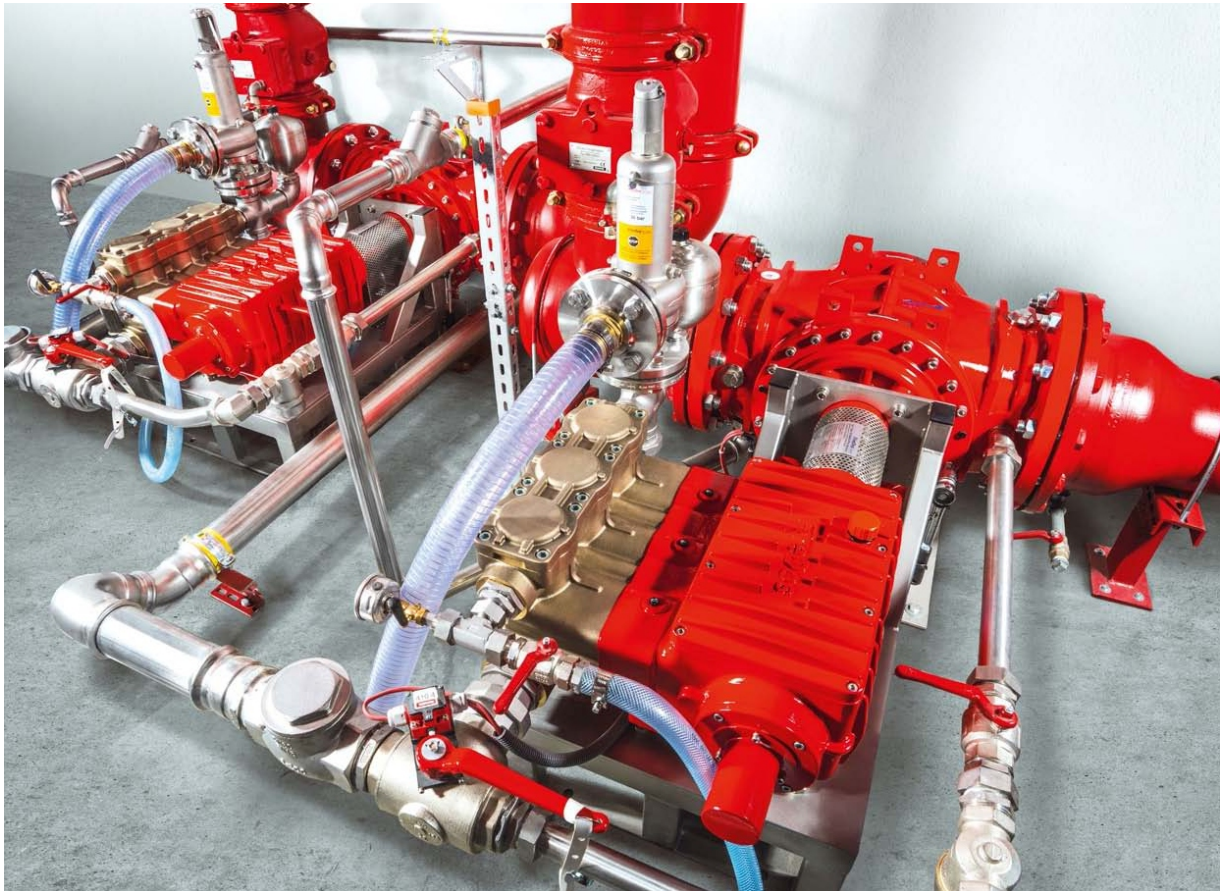

■ FIRE-FIGHTING WITH FOAM. THIS IS OUR COMPETENCE.

Foam is the only way to effectively fight certain fire scenarios. To generate such foam, a foam agent must be precisely admixed to the extinguishing water flow first. Then, air is added as a third component and expands the 'premix' to a fire-fighting foam.

We designed the highly sophisticated FireDos proportioners to contribute to the effectiveness of stationary fire-extinguishing systems through powerful technology.

We use our expertise for active participation in the following major associations and councils in the fire business:

- VdS - Loss Prevention
- bvfa - German Federal Association of Technical Fire Protection
- DIN e. V. - German Institute for Standardization
- vfdb - GFPA German Fire Protection Association
- VDMA - German Engineering Association
- FM - Factory Mutual
- NFPA - National Fire Protection Association



■ PRODUCT OUTLINE.

The FireDos proportioner is driven solely by the extinguishing water flow. Electrical energy is not required. The purely mechanical system is made-to-last and highly reliable.

The water motor drives a specially designed pump which delivers the foam agent into the extinguishing water flow. There is a direct linear relationship between the extinguishing water flow rate in litres per minute and the water motor's number of revolutions.

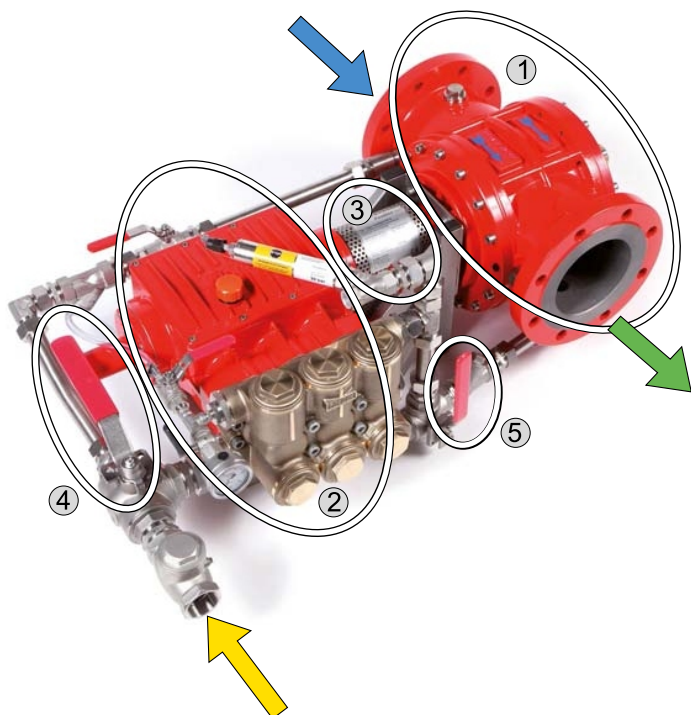
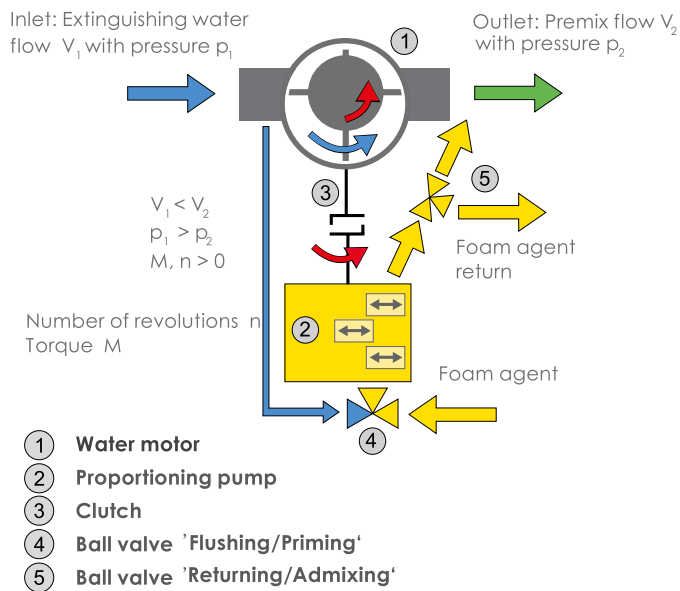

The more water flows through the water motor, the more foam agent is admixed. Thus, the quantitative ratio of foam agent and extinguishing water, which is referred to as the 'proportioning rate', always remains constant.

A portion of the pressure in the extinguishing water line is used as an energy source to drive the water motor. The below graph shows that clever dimensioning of the FireDos proportioner can keep the pressure loss very low:

- Example 1: Pressure loss at a water line pressure of 10 bar and different proportioning rates.

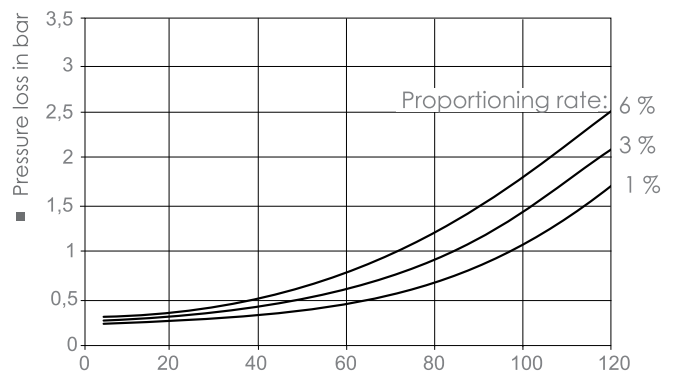

- Extinguishing water flow rate in % of the maximum permitted flow rate of the particular FireDos proportioner

- Example 2: Pressure loss at a proportioning rate of 3% and different water line pressures.

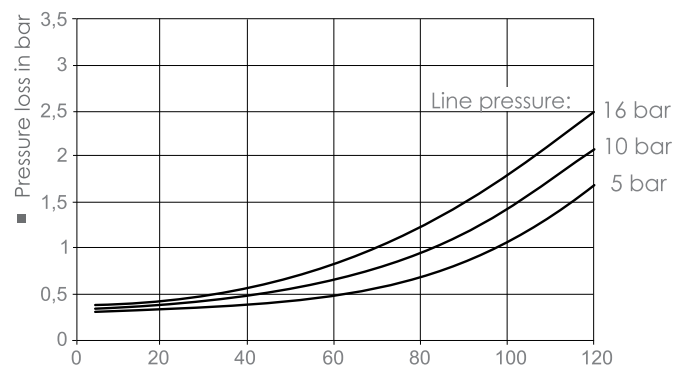

- Extinguishing water flow rate in % of the maximum permitted flow rate of the particular FireDos proportioner

■ THE ADVANTAGES.

■ DESIGNED ESPECIALLY FOR FOAM AGENTS.

The proportioning pump that is driven by the water motor is self-priming and can deliver even extremely viscous fluorine-free and/or alcohol-resistant foam agents without limits.

■ DRIVEN SOLELY BY THE EXTINGUISHING WATER.

No electricity and hence no emergency power supply is required.

■ MAXIMUM OPERATING RANGE

The required proportioning rate is available already from a low minimum extinguishing water flow rate. As prescribed by international sets of regulations, the proportioning rate then is *always* maintained precisely across the entire operating range. Also, the extinguishing water line pressure has virtually no influence.

■ EASY TO OPERATE.

Operating the proportioner just includes a few ball valves to vent the proportioner in the beginning and to put it into a state ready for operation.

■ STURDY AND MADE-TO-LAST.

Only high-quality components and materials are used. All pressurized cast parts are designed for a testing pressure of 64 bar.

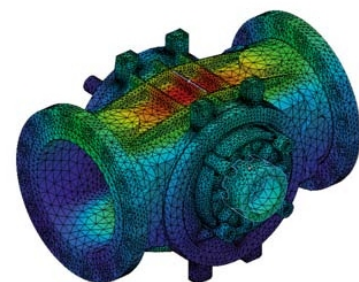
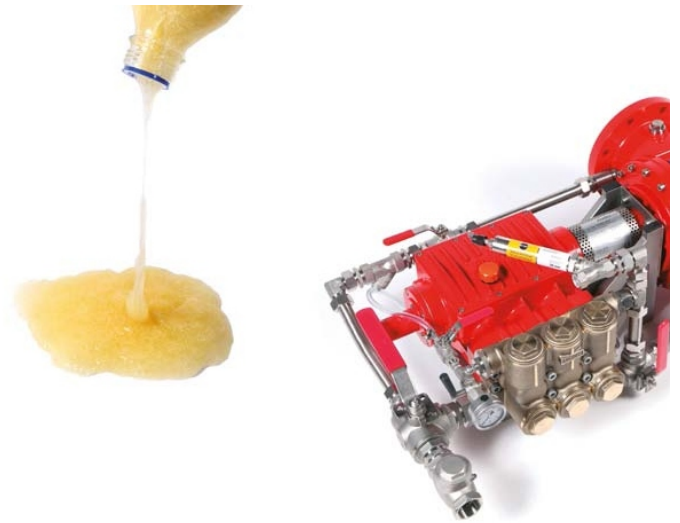

THE ADVANTAGES

■ DIRECT RESPONSE TO THE EXTINGUISHING WATER FLOW.

As soon as the water flows, the water motor starts working and hence driving the proportioner. There are no valves which have to be actuated and could be an error source.

■ CLOSED SYSTEM.

No extinguishing water is lost which would have to be drained into the sewer system or passed back to the water tank!

■ EXACT PROPORTIONING AMOUNT.

The proportioning pump delivers not more than what is really needed. The remaining foam agent will stay in its tank and is not moved.

■ QUICK INSTALLATION AND START-UP.

All components are supplied firmly connected as one unit which is tested for functionality and tightness at our factory.

On site, the water motor is integrated into the extinguishing water line in which no special stabilisation stretches are required. The proportioning pump is firmly mounted and connected to the foam agent tank through a suction line and an optional return line, both of which must be provided by the installer. There is nothing more to do.

The unit can be started up immediately after installation. Any further adjustment is neither necessary nor possible.

■ TESTING THE PROPORTIONING RATE.

This can be done precisely, not having to generate foam or premix.

RESTRICTIONS OF OTHER SYSTEMS

To start the proportioner, an actuated valve ③ must be opened, which is a potential error source.

A portion of the extinguishing water is lost ④ that takes much effort to dispose of ⑧.

Both water tank ① and fire pump ② must be dimensioned larger due to this lost amount of water.

The foam agent is circulated constantly ⑦ and compromised thereby. Only a portion is actually admixed.

Supply as an assembly kit ③④⑤⑦⑨ that must be finally mounted in several places on-site.

Time-consuming adjustment after installation of the various parts ⑦⑨.

The proportioning rate cannot be determined reliably without generating premix or foam.

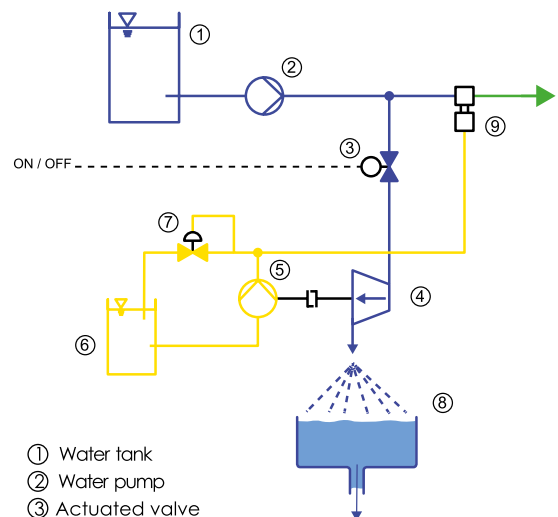

- ① Water tank
- ② Water pump
- ③ Actuated valve
- ④ Turbine
- ⑤ Foam agent pump
- ⑥ Foam agent tank
- ⑦ Constant pressure valve
- ⑧ Water loss
- ⑨ Proportioner

THE ADVANTAGES

■ ENDLESS OPERATION.

Unlike a bladder tank, the separate atmospheric foam agent tank can be refilled when necessary. This allows extinguishing with no time limits.

■ CHANGING THE FOAM AGENT TYPE.

Since the proportioner is suitable for all types of foam agents, it can be changed to another one at any time. Important: If the new foam agent is more viscous than the previous one, it is a must to review the dimensioning of the on-site suction line. We will be pleased to assist you.

■ APPROVALS.

All requirements in international standards set by the law and by insurance companies are met:

- EU machinery directive 2006/42/EG
- CEA 4001
- EN 13565
- NFPA11 and 11A
- Nordtest NT042,
- FM 5130
- UL 162, 162 A and 139

No other proportioner brand all around the world holds as many approvals:

- Factory Mutual (FM)
- VdS
- Germanischer Lloyd
- Numerous national approvals

The use in all types of extinguishing systems is possible without limits: Sprinkler and deluge systems, dry and wet extinguishing systems.



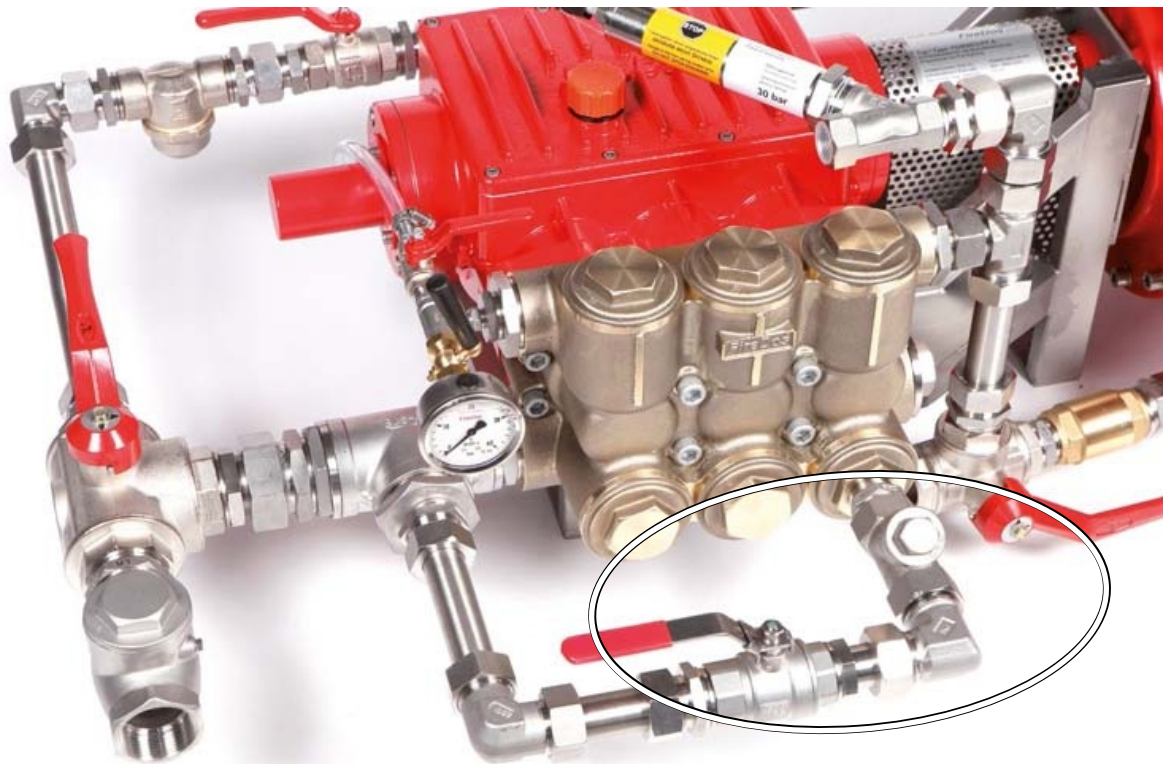

■ TYPE SELECTION.

The type reference starts with the maximum possible extinguishing water flow rate in litres per minute, followed by the proportioning rate(s) in percent.

Adding an optional cylinder cut-off makes a second, lower proportioning rate available to which can be switched by opening a ball valve when required*. In this case single cylinders of the proportioning pump do no longer deliver but merely circulate the foam agent.

Series	Water flow rate	Operating pressure	Proportioning rates
FD500	ca. 60 – 500 l/min	up to 16 bar	Fixed proportioning rates: 0.5 % 1 % 3 % 6 % 3 / 3 % (except FD500)
FD1000	ca. 100 – 1000 l/min		
FD1600	ca. 150 – 1600 l/min		
FD2500	ca. 250 – 2500 l/min		
FD4000	ca. 400 – 4000 l/min		
FD6000	ca. 500 – 6000 l/min		Stepwise adjustable proportioning rates*: 0.2 % / 0.5 % 0.3 % / 1 % 1 % / 3 % 2 % / 3 %
FD8000	ca. 500 – 8000 l/min		
FD10000	ca. 600 – 10000 l/min		
FD15000	ca. 800 – 15000 l/min		
FD20000	ca. 800 – 20000 l/min		

Further proportioning rates are possible.

TESTING THE PROPORTIONING RATE

■ GREEN AND COST-SAVING: TESTING THE PROPORTIONING RATE.

Extinguishing systems must be tested regularly to guarantee their functionality in case of a fire. The same applies to the proportioner.

The optional return line connection can be used to pass the foam agent back into the tank while its quantity is measured under live operating conditions.

The extinguishing water flow rate is measured at the same time, allowing to calculate the proportioning rate.

- Both fluids stay separate.
- No foam or premix is generated.
- This eliminates the risk of contamination and violations of law.
- Not consuming foam agent means saving costs.
- There is no need for costly disposal of foam or premix.

Following, please find an example of an installation layout allowing an extremely simple testing:

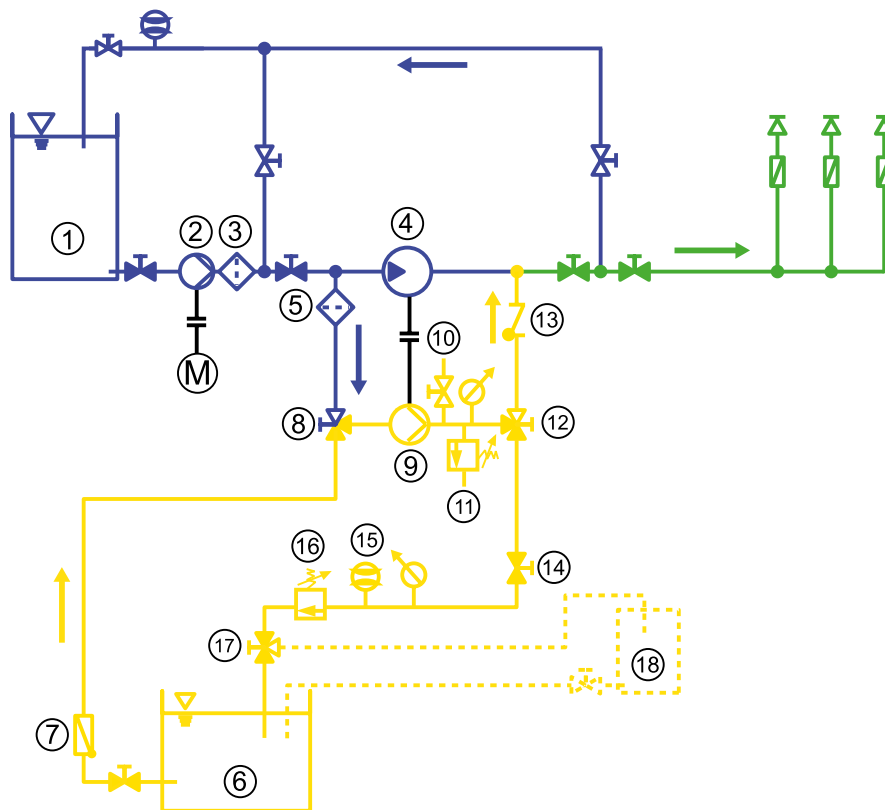

TESTING THE PROPORTIONING RATE

■ HOW TO PROCEED.

- Set the 3-way ball valve 'Returning/Admixing' (12) to 'Returning'.
- Open the water flow to make the proportioner start running.
- Set a pressure equal to the pressure in the extinguishing water line at the second pressure-relief valve (16). This setting will be maintained.
- The foam agent flow rate is read at the flow meter (15).
- The water flow rate must be determined at the same time.

■ THE ALTERNATIVE.

- Instead of using the flow meter, pass the foam agent flow into a collecting tank (18) by turning the 3-way ball valve (17).
- Determine the foam agent volume that is collected here during a certain period of time.
- Likewise, determine the volume of water which flowed during the same period of time.

$$\text{Proportioning rate in \%} = \frac{\text{foam agent}}{\text{water + foam agent}} \times 100$$

- ① Water tank
- ② Water pump
- ③ Strainer
- ④ Water motor*
- ⑤ Flushing line filter*
- ⑥ Foam agent tank
- ⑦ Non-return flap*
- ⑧ 3-way ball valve 'Flushing/Priming'*
- ⑨ Proportioning pump*
- ⑩ Air venting*
- ⑪ First pressure-relief valve (optional)*
- ⑫ 3-way ball valve 'Returning/Admixing' (optional)*
- ⑬ Check valve in the proportioning line*
- ⑭ 2-way ball valve (optional)*
- ⑮ Foam agent flow meter (optional)*
- ⑯ Second pressure-relief valve (optional)*
- ⑰ 3-way ball valve
- ⑱ Collecting tank for foam agent

* Components of the FireDos proportioner

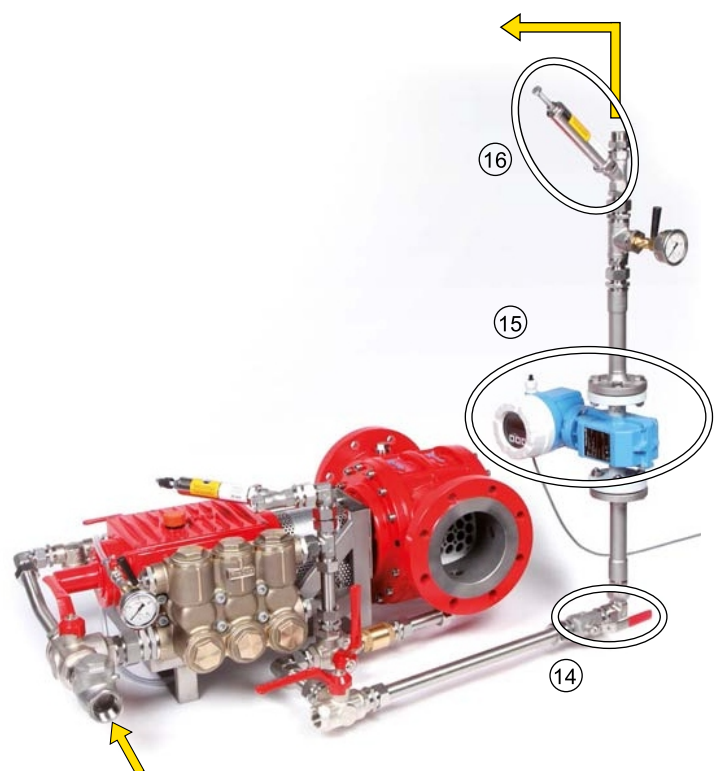

OPTIONAL EQUIPMENT

■ OPTIONAL EQUIPMENT AND VARIANTS.

We are here to meet your requirements. Please find an overview below, showing a further selection of the optional equipment variants which may be helpful or even necessary, depending on the type of extinguishing system:

- Check valves for flushing line and proportioning line to prevent the foam agent tank from running empty under unfavourable system conditions.
- Switch for electrical monitoring of the ball valves 'Returning/Admixing' and 'Flushing/Priming'.
- Volume flow meter for the extinguishing water. A proximity switch measures the water motor's number of revolutions from which the flow rate is calculated.
- Version for operating temperatures of up to 80°C.
- Version for a static pressure in the extinguishing water line of up to 25 bar.
- Remote admixing of the foam agent. The foam agent is not admixed at the water motor's outlet as usual, but anywhere else within the extinguishing system as required. The installer just has to provide a line to this spot.
- Electrical drives 24V DC or 230V AC for remote control of particular ball valves.

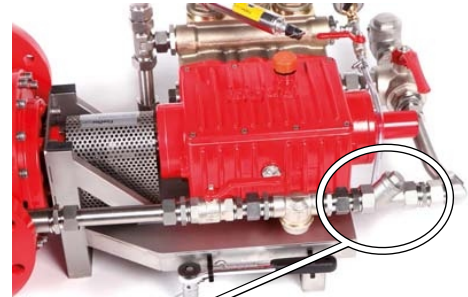

OPTIONAL EQUIPMENT

- ATEX version for explosive areas.
- Versions to use seawater as extinguishing water, with adequately adapted materials.
- Proportional control valve for the following purposes:
 - To open a parallel extinguishing water line where a second proportioner is installed, as soon as the first proportioner approaches its maximum permitted water flow rate.
 - To open a bypass around a proportioner as soon as it approaches its maximum permitted water flow rate, to prevent overload.
- The water motor is available in four different flow directions to suit the on-site installation conditions:
 - Left to right.
 - Right to left.
 - Bottom to top.
 - Top to bottom.
- Special requirements are welcome! Just let us know what you need.

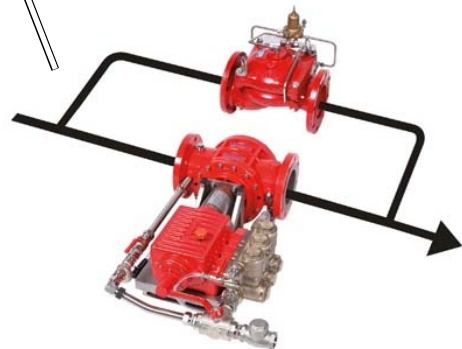
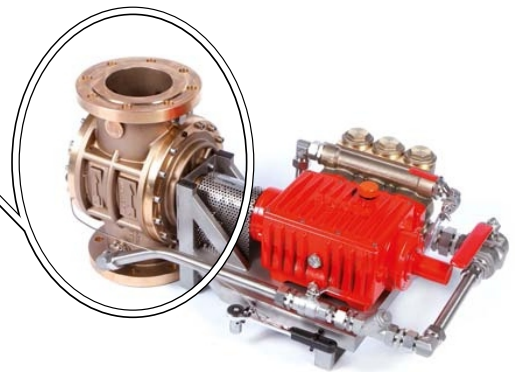
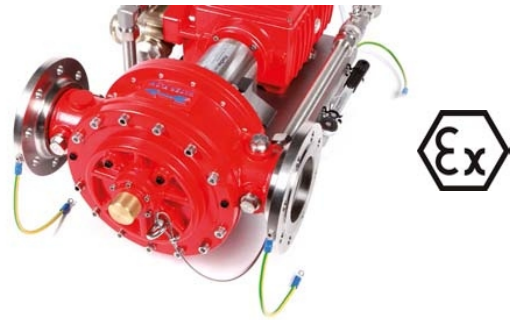



■ WE WANT TO BE YOUR PARTNER .

We are proven experts on our proportioners and monitors for fire-fighting, which we designed all by ourselves. We can meet your challenges and use our experience to find a good technical solution for your extinguishing system. Thousands of our products are used and relied on worldwide. And they are 'Made in Germany.'

As we want to be your partner, we offer you the following additional services:

- Consulting during your planning.
- 3D drawing data to be included in your plans.
- Support in calculating and dimensioning the on-site suction line at your site.
- Nozzle Load Calculation for the water motor by using our finite-elements software.
- Factory acceptance tests using our testing equipment.
- Factory certificates in accordance with DIN EN 10204.
- Commissioning on site.
- Maintenance, also by offering maintenance contracts.
- Training of your staff on a variety of subjects.

Sariak

integrity solutions

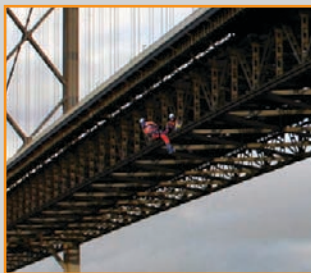

PHONE 0098 21 8873 38 12-3

FAX 0098 21 8876 44 55

WEB www.sariak.com

EMAIL info@sariak.com

Central Office: N0.24, 12th St, Niloofar St,
Apadana Ave., Tehran - Iran

P.O.Box: 16315 - 173